

# JACKS | COUPLERS | WINCHES • TABLE OF CONTENTS

## Jacks

Hydraulic Jacks .....	F-2
A-Frame Jacks .....	F-3
Electric Jacks .....	F-3
A-Frame Jack Replacement Parts and Accessories .....	F-4
Round Pipe Mount Jacks .....	F-4
Square Pipe Mount Jacks .....	F-5
Pipe Mount Jack Replacement Parts and Accessories .....	F-5
Swivel Mount Jacks .....	F-6
Swivel Mount Jack Replacement Parts and Accessories .....	F-6
Marine Pull Pin Swivel Jacks .....	F-7
Marine Pull Pin Swivel Jack Replacement Parts and Accessories .....	F-7
Stabilizer Jacks, Scissor Jacks, Extensions .....	F-7
Light Duty Drop-Leg Jacks 5,000 lbs - 8,000 lbs Capacity .....	F-8
Medium Duty Drop-Leg Jacks 10,000 lbs - 12,500 lbs Capacity .....	F-9
Electric Power Jack Kit 12,000 lbs Capacity .....	F-10 - F-11
Heavy Duty Drop-Leg Landing Gear 25,000 lbs - 55,000 lbs Capacity .....	F-11
Rack and Gear Jacks .....	F-11

## Winches

Manual Hand Winches .....	F-12
Winch Straps and Cable .....	F-12
Electric Winches for Trucks, Trailers & All Terrain Vehicles .....	F-14
Electric Winch Replacement Parts and Accessories .....	F-16

## Couplers

Straight Channel Tongue Couplers .....	F-17
Round Pipe Tongue Couplers .....	F-17
A-Frame Couplers .....	F-18
Adjustable Height Couplers .....	F-19 - F-20
Round Gooseneck Couplers .....	F-19 - F-20
Square Gooseneck Couplers .....	F-20
Gooseneck Coupler Replacement Parts and Accessories .....	F-20
Gooseneck Replacement Inner and Outer Pipe .....	F-20
Kingpin Adapters .....	F-20
Fifth Wheel to Gooseneck Adapters (Offset, Fixed, Cushioned) .....	F-20
Gooseneck Coupler Heads .....	F-20
Draw Bars & Pintle Rings .....	F-21
Flat Mount Couplers .....	F-21
Kingpin Bolster Plates .....	F-21
Fold-Away Coupler Hinge Kits .....	F-21
Coupler Snapper Pins .....	F-21

# JACKS • HYDRAULIC JACKS



Precision 7K Hydraulic Jack designed for bumper hitch trailers applications.

**FEATURES:**

- Center Mounted Hydraulic Ports for fast, easy installation
- Bolt-On Ready
- Painted Black
- Power Up / Power Down
- Universal Mounting Bracket
- 24" Travel Distance
- Removable Foot

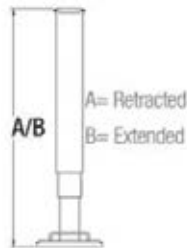

Removable Foot - Hose Ports & Plate - Plug into Hydraulics



**HYDRAULIC JACKS**

REF NO.	ITEM NO.	CAPACITY	A • INCHES • B		REMARKS
1	7950680*	7,000	32.00	56.00	24" HYDRAULIC LIFT
2	7950692	-	-	-	HOSE KIT ASSEMBLY
3	7950588 <sup>3</sup>	12,000	37.40	63.40	26" HYDRAULIC LIFT
4	7950709 <sup>1</sup>	12,000	37.40	63.40	26" HYDRAULIC LIFT
5	7950714 <sup>2</sup>	12,000	37.40	63.40	26" HYDRAULIC LIFT W/PUMP
6	7950713 <sup>2</sup>	24,000	37.40	63.40	26" HYDRAULIC LIFT W/PUMP

\* Designed to accept all pump manufacturers up to 3,200 psi.

**1 - For trailers with existing hydraulics. 2 - For trailers without hydraulics. 3 - Bolt-on and power up.**

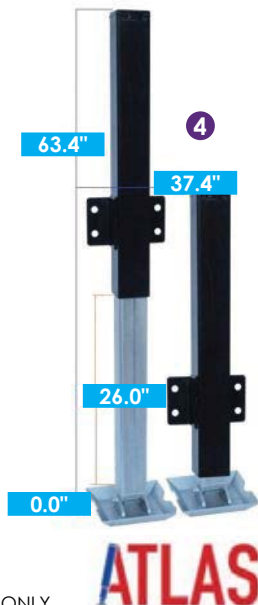

**Stillwell Jacks Atlas Hydraulic Jack** is designed for rugged light and medium duty trailer users. The world's fastest and most affordable hydraulic jack that's flexible enough to work with nearly any trailer design for a wide range of environments.

**FEATURES:**

- 26" of Power Up / Power Down Travel.
- Swivel foot ensures solid ground contact.
- Guide bearings eliminate metal on metal friction and galling.
- Designed to easily tie into existing truck or trailer hydraulics.
- Bolt on or Weld on applications.
- Available in jack leg only or as all-in-one **Atlas Backpack Jack** with enclosed Bucher Hydraulic Pump with 10K lifting force. Also includes 15' corded remote controller. Powder coated steel cover and standard universal mounting brackets.
- Battery power cords require separate purchase: 7000925 & 7000926.



TWO JACKS ARE SHOWN ONLY FOR ILLUSTRATION.



JACKS • HYDRAULIC JACKS

# JACKS • A-FRAME JACKS =



• ZINC



• ZINC



TOP WIND			MEASUREMENT IN INCHES			ID NO.
REF NO.	ITEM NO.	CAPACITY	A	B	C	
1	7950055	1,000	12.00	27.00	17.00	155300
2	7950502	2,000	5.50	19.50	13.50	TJA2001B
3	7950497-TT	2,000	8.00	22.00	11.00	TJA200BT
4	7950483	7950497-TT 2K JACK WITH ZINC FOOT				
5	7950504	2,000	9.00	24.00	14.00	TJA2002B
6	7950501	2,000	8.00	22.00	11.00	TJA2000Z
7	7950506	2,000	10.50	24.50	8.50	TJA5000TB
8	7950505-TT	5,000	10.50	25.50	11.50	TJA5000BT
9	7950057	2,000	10.00	24.00	12.40	80401
-	7950061	5,000	10.80	25.00	14.20	80391
10	7950188	2,000	5.40	20.40	16.00	155033
11	7950054	2,000	7.50	22.50	17.00	155100
12	7950056	2,000	8.20	23.20	12.20	155022
13	7950043	2,000	8.40	23.40	13.00	155028
14	7950193	5,000	10.30	25.30	10.20	155032
15	7950019	5,000	12.25	27.25	13.75	175000

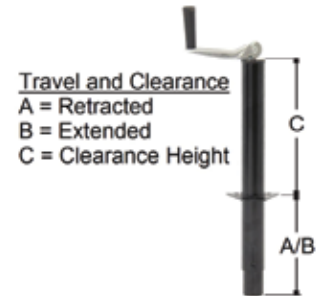

ELECTRIC JACK			MEASUREMENT IN INCHES			ID NO.
REF NO.	ITEM NO.	CAPACITY	A	B	C	
16	7950369-TT	3,500	24.88	39.25	14.75	TTEJ35
17	7950159	4,000	24.80	39.30		81070
-	7950480	MANUAL HANDLE FOR ATWOOD ELEC JACK				

SIDE WIND			MEASUREMENT IN INCHES			ID NO.
REF NO.	ITEM NO.	CAPACITY	A	B	C	
18	7950503	2,000	9.00	23.50	16.00	2000S
19	7950314	3,000	7.00	20.00	14.50	155010



= JACKS • A-FRAME JACKS

# JACKS • A-FRAME JACKS Cont. | PIPE MOUNT JACKS



## A-FRAME JACK PARTS

REF NO.	ITEM NO.	DESCRIPTION	ID NO.
1	7950512	POLY CASTER 1.2K - FOR 2" TUBE	JC101
2	7950243	REPLACEMENT WHEEL KIT FOR 7950512	JWK6P
3	7950244	JACK FOOT PAD SHORT 2K	JF99
4	7950508	JACK FOOT 1.7" HIGH W/PIN 2K - FOR 2" TUBE	101015
5	7950510	JACK FOOT 8.5" HIGH W/PIN 2K - FOR 2" TUBE	106752
6	7950561	DROPLEG FOR 2" JACK INCLUDES PIN - 5 POSITION 8" TOTAL TRAVEL	500329
7	7950300	AUTO FOLDING JACK FOOT 6" 5K CAPACITY	880065
8	7950097	BULLDOG 2K SIDEWIND HANDLE & GEARS	500256
9	7950513	STEEL CASTER 1.2K - FOR 2" TUBE	JC102
10	7950013	BULLDOG PINLOCK CASTER 1K FOR 7950055	17125
11	7950239	REPLACEMENT HANDLE 2K TOPWIND	130511
12	7950242	REPLACEMENT HANDLE 2-5K JACKS	500180
13	7950514	JACK BOTTOM PLATE FOR 2K & 5K A-FRAME JACKS	250-00

## Pipe Mount Trailer Jacks

Pipe or tube is welded to the trailer frame, providing a mount for the jack to pivot - down for jacking and stabilizing, and up for towing.

- Capacity: 2,000 - 7,000-LBS
- Pivots around a tube that is welded to the trailer frame
- Comes in two styles - top crank or side wind crank
- Held in up or down position by pin
- Mounted typically on the trailer tongue but often found at side of frame to aid in stabilizing and leveling
- Usually 10" or 15" Lift



PIPE MOUNT JACKS			MEASUREMENT IN INCHES			
REF NO.	ITEM NO.	CAPACITY	A	B	C	PIN SIZE
14	7950046	2,000	11.00	21.00	4.00	9/16"
15	7950525-TT	2,000	11.25	21.25	4.00	9/16"
16	7950050	2,000	14.50	29.50	10.00	9/16"
17	7950527	2,000	20.25	35.25	5.25	9/16"
14	7950064	5,000	11.25	21.25	4.00	9/16"
15	7950530	5,000	11.25	21.25	4.00	9/16"
16	7950069	5,000	14.75	29.75	4.00	9/16"
17	7950533	5,000	15.00	30.00	4.00	9/16"
18	7950067	5,000	10.60	25.10	14.00	7/8"
19	7950081	7,000	10.75	20.75	4.50	5/8"
20	7950078	7,000	15.75	30.75	4.25	5/8"

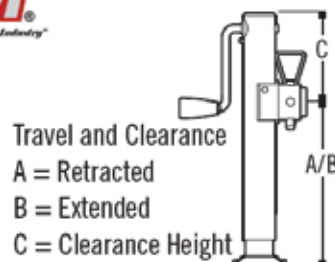

# JACKS • PIPE MOUNT JACKS Cont. =



ROUND SIDE WIND			MEASUREMENT IN INCHES			
REF NO.	ITEM NO.	CAPACITY	A	B	C	PIN SIZE
1	7950540-TT	2,000	11.25	21.25	6.25	9/16"
2	7950048	2,000	10.75	20.75	6.40	9/16"
3	7950044	2,000	14.50	29.50	12.25	9/16"
4	7950066	5,000	10.40	20.40	6.40	5/8"
1	7950532-TT	5,000	10.25	21.25	7.25	9/16"
5*	7950065	5,000	15.40	30.40	6.40	5/8"
6	7950535	5,000	16.25	31.25	7.25	9/16"
7	7950079	7,000	11.00	21.00	6.40	5/8"
8	7950080	7,000	16.00	31.00	6.40	5/8"

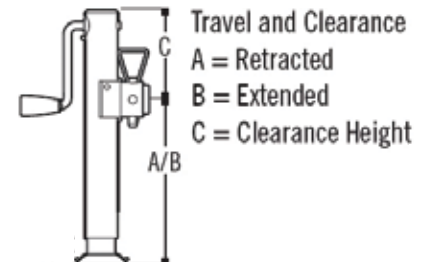

## \* FEMALE PIPE MOUNT JACK

PIPE JACK PARTS			
REF NO.	ITEM NO.	DESCRIPTION	ID NO.
9	7950239	REPLACEMENT HANDLE 2K TOPWIND	TJA2000
10	7950242	REPLACEMENT HANDLE 2-7K JACKS	TJPB
11	7950108	REPLACEMENT HANDLE BULLDOG 190 SERIES	500148
12	7950102	REPLACEMENT HANDLE BULLDOG 190 SERIES	500171
13	7950096	REPLACEMENT HANDLE RAM UP TO 7K SW	TJD7000SH
14	7950226	REPLACEMENT HANDLE 8K	TJD7000H
15	7950088	REPLACEMENT CAP BULLDOG 150 SERIES	500326
16	7950113	REPLACEMENT PIN 5/8" x 3-1/2"	TJP58
16	7950016	REPLACEMENT PIN 9/16" x 3-1/2"	TJP916
17	7950114	REPLACEMENT PIN 5/8"x 4-1/2" BULLDOG SW	500232
18	7950131	9/16" PIN HOLE MALE MOUNT 2-5K	TJPIP916
19	7950130	5/8" PIN HOLE MALE MOUNT 2-5K	TJPIP58
20	7950129	5/8" PIN HOLE FEMALE MOUNT 7K	500238



SQUARE PIPE MOUNT			MEASUREMENT IN INCHES			
REF NO.	ITEM NO.	CAPACITY	A	B	C	Handle
21	7950236	5,000	15.75	31.00	8.50	TOP
22	7950237	5,000	15.75	31.00	8.50	SIDE
23	7950271	8,000	11.41	21.41	4.25	TOP
24	7950258	5,000	15.10	30.10	7.00	SIDE
25	7950254	5,000	15.20	30.20	9.25	TOP



Pipe Mount Jack mounted on the frame of a trailer for stabilization or leveling.

# JACKS • SWIVEL MOUNT JACKS =



## Pull Pin Swivel Trailer Jacks

Pull Pin swivel jacks bolt on or weld on to the trailer frame, providing a mount for the jack to pivot - down for jacking and stabilizing, and up for towing.

- Bolt On Style fits frame sections up to 3" Wide x 5" Tall
- Weld On Style mounts to frame in any convenient location
- Pull pin holds jack in position - pin is pulled to release jack for changing positions
- Capacity: 2,000 - 7,000 -LBS
- Comes in two styles - top crank or side wind crank
- Held in up or down position by pin
- Usually 10" or 15" Lift

• BEST VALUE



• ZINC

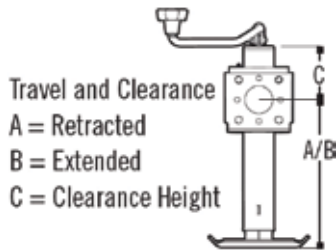

TOP WIND			MEASUREMENT IN INCHES		
REF NO.	ITEM NO.	CAPACITY	A	B	C
1	7950180-TT	2,000	11.25	21.25	4.00
2	7950047	2,000	11.00	21.00	4.00
3	7950523	2,000	15.00	30.00	4.00
4	7950051	2,000	14.50	29.50	10.00
5	7950062	5,000	11.25	21.25	4.00
4	7950063	5,000	14.50	29.50	10.00
7	7950520	2,000	10.00	25.25	4.00

SIDE WIND			MEASUREMENT IN INCHES		
REF NO.	ITEM NO.	CAPACITY	A	B	C
6	7950049	2,000	11.00	21.00	6.40



## SWIVEL JACK PARTS

REF NO.	ITEM NO.	DESCRIPTION	ID NO.
8	7950242	REPLACEMENT HANDLE 2-7K JACKS	500180
9	7950102	REPLACEMENT HANDLE BULLDOG 190 SERIES	500171
10	7950248	PLUNGER ASSEMBLY 1/2" RAM	PLGPIN
11	7950157	PLUNGER PIN ASSEMBLY 1/2" BULLDOG	500178
12	7950116	2" SNAP RING FOR RAM	SNP-RING
12	7950111	SNAP RING FOR HB	500241

# JACKS • MARINE JACKS | STABILIZER JACKS



## Pull Pin Swivel Marine Trailer Jacks

Pull Pin swivel marine jacks typically bolt on to the trailer frame, providing a mount for the jack to pivot - down for jacking and stabilizing, and up for towing.

- Bolt On Style fits frame sections up to 3" Wide x 5" Tall
- Pull pin holds jack in position - pin is pulled to release jack for changing positions
- Capacity: 800 - 2,500 -LBS
- Typically side wind crank style
- Usually zinc coated for extra corrosion resistance from salt water exposure
- Held in up or down position by pin
- Most common fixture is a caster or double casters
- Usually 10" or 15" Lift



**FULTON**  
 • ZINC  
 • 600 HOUR  
 SALT SPRAY  
 RATING PER  
 ASTM B117



BOLT ON			MEASUREMENT IN INCHES			
REF NO.	ITEM NO.	CAPACITY	A	B	C	LEG
1	7950515-TT	1,200	12.70	22.70	10.50	SWIVEL
2	7950266-TT	1,500	12.70	22.70	12.50	SWIVEL
3	7950518	1,500	12.70	22.70	10.50	SWIVEL
4	7950038	1,200	12.25	22.50	10.50	SWIVEL
5	7950084	1,500	13.00	23.00	12.40	SWIVEL
6	7950228	1,500	13.10	25.10	12.40	SWIVEL
7	7950235	1,200	9.30	24.30	19.50	FIXED
9	7950232	1,600	14.00	24.00	12.40	SWIVEL
10	7950231	1,600	14.00	24.00	12.40	SWIVEL-SINGLE
8	7950539	2,500	7.00	22.00	18.50	DROP LRG-DUAL



Travel and Clearance Diagram  
 A= Range

MARINE JACK REPLACEMENT PARTS		
REF NO.	ITEM NO.	DESCRIPTION
11	7950243	REPLACEMENT WHEEL KIT FOR 7950515
12	7950578	REPLACEMENT WHEEL KIT FOR 7950232
13	7950366	REPLACEMENT WHEEL KIT FOR 7950231
14	7950248	PLUNGER ASSEMBLY 1/2"
15	7950635	REPLACEMENT CAP RAM
16	7950641	REPLACEMENT CAP XP10 FOR 7950038
17	7950642	REPLACEMENT CAP XP15 FOR 7950084/228
18	7950096	REPLACEMENT HANDLE RAM
19	7950344	REPLACEMENT HANDLE XP10 FOR 7950038

STABILIZER JACKS			INCHES	DESCRIPTION
REF NO.	ITEM NO.	CAPACITY	A	DESCRIPTION
20	7950151	3,000	27.00	INCLUDES SLEEVE AND PIN
21	7950600	2,000	20.00	INCLUDES SLEEVE AND PIN
22	7950023-TT	1,000	17.00	RETRACTED HEIGHT 11.50"
23	7950098	-	-	HANDLE FOR 7950023-TT
24	7950801	5,000	24.00	CAPACITY PER PAIR
25	7950800	-	-	HANDLE FOR 7950801



JACKS • MARINE JACKS | STABILIZER JACKS

# JACKS • DROP-LEG JACKS =



## Drop-Leg Trailer Jacks

- Either welded or bolted to side of the trailer tongue or most forward cross member.
- Capacity: 5,000 - 12,500 - LBS.
- Typical Applications: Agricultural, Industrial and Construction.
- Square cross section offers improved side-load strength over other designed jacks.
- Drop-leg features enable fast leveling and increased lift abilities.
- Saves time when raising and lowering:
  - Pull the drop leg extension retaining pin to adjust the inner leg and foot.
  - Align holes of the inner and outer drop-leg tubes, reinsert pin to secure the desired height.
  - Crank the jack to raise or low the trailer. NOTE: Because of the drop-leg feature the required cranking is reduced.
- Some Brands and Models can be paired with a second jack (slave) that will work together in tandem enabling a higher capacity lift. Additionally, some Brands and Models can be equipped with an electric motor added convenience.
- Lift varies between 18" - 32" depending upon drop-leg length and travel of the selected jack.



**• 12K HOLD**  
**• 10K LIFT**

While it is NOT a Drop-Leg Jack, the **Stillwell Atlas Hydraulic Jack** is designed for rugged light and medium duty trailer users. The world's fastest and most affordable hydraulic jack that's flexible enough to work with nearly any trailer design for a wide range of environments. See page F-2 for details.

LIGHT DUTY DROP-LEG JACKS			INCHES		
REF NO.	ITEM NO.	CAPACITY	A	B	DESCRIPTION
1	7950543	5,000	25.50	54.00	13" DROPLEG
2	7950181-TT	8,000	23.50	54.00	15" DROPLEG
3	7950182-TT	8,000	25.50	54.00	15" DROPLEG
4	7950076	8,000	22.66	51.41	13" DROPLEG
5	7950077	8,000	25.06	53.56	13" DROPLEG
6	7950400-TT	8,000	23.00	35.00	15" DROPLEG
7	7950226	REPLACEMENT HANDLE 8K			
8	7950162	REPLACEMENT FOOT PIN 9/16"			

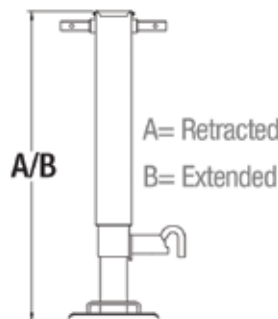

"The Best Overall Value In The Industry"



# JACKS • DROP-LEG JACKS Cont. =



MEDIUM DUTY • NON-SPRING RETURN			INCHES			
REF NO.	ITEM NO.	CAPACITY	A	B	PIN	HANDLE
1	7950562-TT	10,000	23.5"	49.0"	SIDE	YES
2	7950026	10,000	23.4"	49.4"	SIDE	YES
3	7950255	12,500	24.3"	50.3"	DUAL	NO
4	7950147-TT	10,000	28.5"	54.0"	FRONT	YES
5	7950031	10,000	27.4"	53.3"	SIDE	NO
5	7950034	10,000	27.4"	53.3"	SIDE	YES
6	7950030	10,000	28.6"	54.6"	FRONT	NO
6	7950223	10,000	28.6"	54.6"	FRONT	YES



MEDIUM DUTY - SPRING RETURN			INCHES			
REF NO.	ITEM NO.	CAPACITY	A	B	PIN	HANDLE
7	7950256	20,000	24.30"	50.30"	DUAL	NO
8	7950251	12,000	24.40"	49.90"	SIDE	NO
9	7950118	12,000	28.25"	54.25"	FRONT	NO
10	7950146-TT	12,000	28.50"	54.00"	SIDE	YES
11	7950281-TT	12,000	28.50"	54.00"	FRONT	YES
12	7950022	12,000	27.40"	53.60"	SIDE	NO
-	7950224	10,000	27.40"	53.60"	SIDE	YES
13	7950170	10,000	28.60"	54.60"	FRONT	NO
-	7950360	10,000	28.60"	54.60"	FRONT	YES

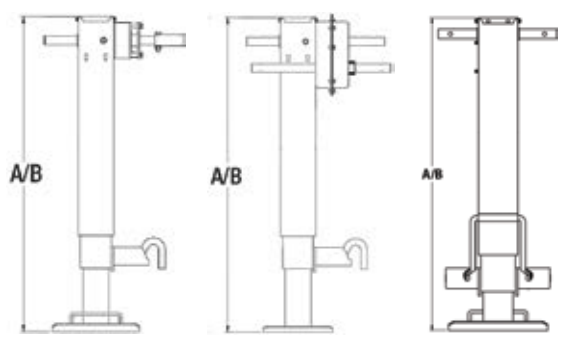

MEDIUM DUTY - DUAL SPEED			INCHES				
REF NO.	ITEM NO.	CAPACITY	A	B	PIN	SPRING RTN.	SLAVE
14	7950027	10,000	29.5"	54.6"	FRONT	NO	7950030
15	7950203	10,000	29.5"	55.6"	FRONT	NO	7950030
16	7950205	10,000	29.5"	55.6"	FRONT	YES	7950170
17	7950207	10,000	29.5"	55.6"	FRONT	YES	7950170
18	7950466	25,000	28.5"	54.5"	FRONT	YES	-



= JACKS • DROP-LEG JACKS

# JACKS • POWER DRIVE KITS

POWER DRIVE KIT FOR MEDIUM DUTY BULLDOG JACKS

## HIGH SPEED VELOCITY SERIES

- Fits a variety of applications for OEM and Aftermarket Industrial, Horse & Livestock, and RV Applications.
- Easy to install – Mounts without welding and requires no hydraulic oil, hoses, or pumps.
- Fully Powered – 12,000 lbs. capacity per leg with Proprietary high-speed system.
- 24" of travel.
- Includes wired remote.
- Resists corrosion with premium powder coat finish.
- Manual override in case of power loss.
- 5 year limited warranty.



•7950603

## POWERED DRIVE KIT



7,500 LB. LIFT CAPACITY

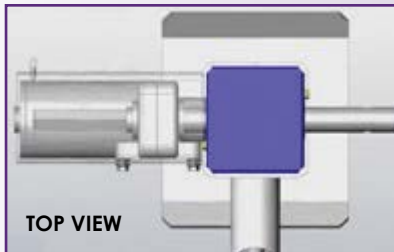

### LIFTS 50% MORE THAN THE COMPETITION

- Lifts 3" per minute at typical working loads
- Can be manually cranked in power loss
- State of the art 12VDC electric motor
  - Quiet operation – 50% quieter than competitive units
  - Efficient use of electrical power – 60% more effective than competitive units
  - Permanently lubricated to provide years of maintenance free use
- Custom designed wiring harness and rocker switch enclosed in a weather proof box
  - Utilizes a 25 amp circuit breaker with push button reset feature
- Can be used in both single and tandem jack applications
- Kit includes all necessary components for ease of installation
  - Power drive assembly
  - Torque stop tube with energy absorption device
  - Terminal box
  - Wiring harness and switch box
  - Hex coupling (required when using in a tandem jack application)
  - Weather resistant cover



- DESIGNED SPECIFICALLY FOR USE WITH BULLDOG 12,000 LB. JACKS



•7950200

# JACKS • POWER DRIVE KITS | RACK & GEAR

## Power Drive Kit For Medium Duty Bulldog & Holland Jacks

The Magnum Electric Lift is an easy upgrade, designed to convert your manual jack into a power jack capable of lifting up to 6,500 lbs. of jack weight at 7" per minute. Comes complete with everything you need for easy installation. The motor has a built-in manual crank override in case of battery failure. The Magnum Electric Lift takes the strain out of cranking your trailer with a convenient raise/lower trailer switch.

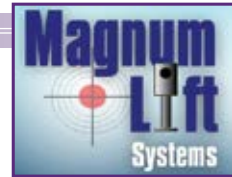

•7950133

•7950212 & 7950213 KITS INCLUDE: JACK SET, CROSSPIPE, HANDLE AND CLIP.



•IDEAL FOR HORSE, LIVESTOCK & HEAVY DUTY TRAILERS

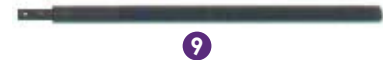

MEDIUM DUTY - DUAL SPEED		
ITEM NO.	DESCRIPTION	ID NO.
7950200	7.5K FOR USE ON BULLDOG JACKS	182420
7950132	SINGLE SPEED 12v POWER LIFT KIT	LEGB1
7950133	DUAL SPEED 12v POWER LIFT KIT	LEGB2

## Landing Gear

HEAVY DUTY - DUAL SPEED					
REF NO.	ITEM NO.	CAPACITY	A	B	REMARKS
1	7950042	25,000	31.20"	48.20"	SINGLE SPEED W/BRACKET
2	7950041	25,000	31.20"	48.20"	2- SPEED W/BRACKET
-	7950212	50,000	ABOVE SET W/ HANDLE AND 68" CROSSPIPE		
3	7950240	50,000	31.19"	48.19"	SINGLE SPEED W/BRACKET
4	7950241	50,000	31.19"	48.19"	2- SPEED W/BRACKET
-	7950213*	55,000	ABOVE SET W/ HANDLE AND 68" CROSSPIPE		

\* 7950213 HAS STATIC LIFT OF 70,000 LBS. BUT AS LANDING GEAR SET CAPACITY 140,000 LBS.

HEAVY DUTY - DUAL SPEED • JACK HANDLES				
REF NO.	ITEM NO.	DESCRIPTION	REF NO.	
5	7950091	JACK HANDLE 6", BLACK, 13.5" RADIUS	LG0083-01	
6	7950092	JACK HANDLE 18", BLACK, 13.5" RADIUS	LG0083-05	
7	7950260	JACK CONNECTING PIPE, 68" CUT TO LENGTH	LG0094	
8	7950168	JACK HANDLE CLIP	LG0085	
9	5350132	JACK CRANK EXTENSION 46.25"	CP42	



## Rack & Gear Jacks

### •MOUNTING OPTIONS

<p>•7950070 161 Series</p>	<p>•7950074 165 Series</p>	<p>TOUGH &amp; TRUSTED BULLDOG</p>	<p>•7950163 162 Series</p>	<p>•7950071 169 Series</p>
<p>•L-BEND BRACKET WELD-ON Welds to side &amp; bottom of tongue</p>	<p>•A-FRAME Welds or bolts to top of A-frame coupler</p>		<p>•L-BEND BRACKET BOLT-ON Fits up to 4" square tongue</p>	<p>•BOLT-ON Fits up to 3" x 5" rectangular tongue</p>

•CASTER WHEELS  
Polyolefin Wheel  
750 lbs. capacity



•7950261  
"R" MODELS

•STEEL WHEEL  
750 lbs. capacity



•7950119  
"W" MODELS



•DISC FOOT  
Welded to Jack Post  
750 lbs. capacity

•7950018  
"D" MODELS

# WINCHES =

# FULTON



1



2



3



4



5



6



7



8



10



11



12



9

## SINGLE SPEED

REF NO.	ITEM NO.	CAPACITY	GEAR RATIO	STRAP	FREE SPOOL	STORAGE
1	9850015	0.6K	3.1:1	NO	CENTER	15'
-	9850099	1.1K	4.1:1	NO	CENTER	20'
-	9850098	1.3K	4.1:1	NO	CENTER	20'
-	9850104	1.4K	4.4:1	NO	OFF	31'
2	9850017	1.5K	4.1:1	NO	CENTER	20'
-	9850073	1.6K	5.4:1	NO	OFF	45'
-	9850228	1.6K	4.1:1	NO	CENTER	23'
-	9850014	1.8K	5.1:1	NO	CENTER	20'
3	9850074	1.8K	5.4:1	NO	CENTER	38'
-	9850167	0.6K	3.1:1	YES	OFF	23'
-	9850232	1.0K	4.4:1	YES	OFF	23'
4	9850168	1.4K	4.4:1	YES	OFF	23'
-	9850169	1.6K	4.4:1	YES	OFF	23'

## TWO SPEED

REF NO.	ITEM NO.	CAPACITY	GEAR RATIO	STRAP	FREE SPOOL	STORAGE
5	9850019	2.0K	9.8:1/4.1:1	NO	CENTER	20'
-	9850075	2.0K	12.4:1/5.4:1	NO	CENTER	38'
6	9850076	2.5K	17.3:1/4.1:1	NO	CENTER	38'
-	9850032	2.6K	12.2:1/5.1:1	NO	CENTER	20'
7	9850020	3.2K	12.2:1/5.1:1	-	CENTER	CABLE / BRAKE
-	9850111	3.2K	17.3:1/4.1:1	NO	CENTER	25'

## STRAP / CABLE

REF NO.	ITEM NO.	DESCRIPTION
8	9850179	WINCH STRAP 2" x 15' WITH HOOK 1.4K WORKING LOAD LIMIT - 4K CAP.
-	9850178	WINCH STRAP 2" x 20' WITH HOOK 1.4K WORKING LOAD LIMIT - 4K CAP.
9	9850018	WINCH STRAP 2" x 20' WITH HOOK 2.6K WORKING LOAD LIMIT
10	9850095	WINCH STRAP 2" x 20' WITH HOOK 4K WORKING LOAD LIMIT - 10K CAP.
11	9250157	SOFT LOOP EXTENDER 1" x 18" 1.17K WORKING LOAD LIMIT
12	9850034	WINCH CABLE 7/32" x 50-FT WITH HOOK



# TRAILER WINCHES

WINCHES-MOUNTS-RIGGING-WIRING

Not All Winches Are Created Equal!



## ADVANTAGES



BDW Trailer Winches	Other Winches
1) Mounting Plate Included	Mounting Plate Not Included
2) Flat assembly using countersunk hardware mounts to flat trailer deck	Uses hex head mounting hardware which makes mounting on flat trailer deck more difficult
3) Easy rope handling -narrow drum -tensioner	Easy to tangle rope -too much rope -no tensioner
4) Low Profile – 8" or less	Box on top easy to get damaged
5) 20' wired controller & wireless ready	12' wired controller
6) Automatic in-drum load holding mechanical brake	Some winches have dynamic brake which is less dependable

# WINCHES • ELECTRIC WINCH COMPARISON =



## TRAILER WINCHES VS. POWERSPORT WINCHES



**Not All Winches Are Created Equal!**

<span style="font-size: 2em;">+</span> <b>9850175 3.4K Trailer Winch</b> <b>9850172 4.4K Trailer Winch</b>	<b>POWERSPORT WINCHES</b> <span style="float: right; font-size: 2em;">-</span>
All-in-one design - easy to mount	Winch, contactor, & switch are all separate and installer has to mount and wire each separately - difficult to mount
Winch mounts to plate with counter sunk bolts - mounts flat to trailer deck	Uses hex head bolts which will cause problems mounting on flat trailer deck
Includes spring steel tension plate for wire rope - easy rope management and spooling	Tension Plate Usually Not Included - wire rope will unwind off drum when not under tension
20-ft wired controller - use at back of most trailers	Includes handlebar switch or 8 to 12-ft wired controller - not useful for trailers
Fairlead mounts to plate above deck level	Sometimes fair lead is below deck level - causes problems when mounting on trailer deck
Wireless Ready - easy plug-in mount and design for exposed outdoor use	Wireless is hard-wired and not designed for exposed outdoor use
Mechanical brake in drum - better for holding loads	Sometimes dynamic brake - not great for holding loads



1



2

TRAILER WINCH - 3.4K - 4.4K		
REF NO.	ITEM NO.	DESCRIPTION
1	9850175	ELECTRIC PLANETARY WINCH 3.4K 1.5HP WITH 50' CABLE
2	9850172	ELECTRIC PLANETARY WINCH 4.4K 1.7HP WITH 50' CABLE

= WINCHES • ELECTRIC WINCH COMPARISON

# WINCHES • ELECTRIC WINCH COMPARISON =



## TRAILER WINCHES VS. TRUCK WINCHES



**Not All Winches Are  
Created Equal!**

+ 9850170 5.8K Trailer Winch 9850173 7.8K Trailer Winch	TRUCK WINCHES -
All-in-one design - easy to mount - Includes mounting plate	Most do not include mounting plate - sold separately
Winch mounts to plate with counter sunk bolts - mounts flat to trailer deck	Uses hex head bolts which will cause problems mounting on flat trailer deck
Includes spring steel tension plate for wire rope - easy rope management and spooling	Tension Plate Usually Not Included - wire rope will unwind off drum when not under tension
47 to 55 ft. wired rope on narrow drum long enough for most trailers and make spooling easier / low maintenance	90 to 100 ft. wire rope on wide drum causes lots of problems when used on trailer - rope can bunch up on one end and break winch
Fairlead mounts to plate above deck level	Sometimes fair lead is below deck level - causes problems when mounting on trailer
20 ft. wired controller - use at back of most trailers	Most wired controllers are 12 ft. and not useable on most trailers
Low profile - power unit, motor terminals, & shifter are all mounted low clearance	Most power units, terminals & shifter are mounted on top of winch and its easier to run into and break
Fits inside 20" Box 10" Deep	Requires at least 24" Box 12" Deep



TRAILER WINCH		
REF NO.	ITEM NO.	DESCRIPTION
1	9850170	ELECTRIC PLANETARY WINCH 5.8K 1.9HP WITH 55' CABLE
2	9850173	ELECTRIC PLANETARY WINCH 7.8K 5.2HP WITH 47' CABLE

NOTE: 12K Trailer Winch Available by Special Order.

# WINCHES • ELECTRIC WINCHES *Cont.*



## TRUCK / POWERSPORT WINCH

REF NO.	ITEM NO.	DESCRIPTION
1	9850113	ELECTRIC ATV WINCH 3K 1.2HP WITH 40' CABLE
2	9850125	ELECTRIC TRUCK WINCH 8K 5.2HP WITH 100' CABLE
3	9850171	ELECTRIC TRUCK WINCH 12.5K 6HP WITH 90' CABLE
4	9850133	ELECTRIC TRUCK WINCH 15K 7.2HP WITH 92' CABLE



## BULLDOG ELECTRIC WINCH ACCESSORIES

REF NO.	ITEM NO.	DESCRIPTION	ID NO.
	5	WINCH RECEIVER MOUNT	20155
	6	UNIVERSIAL WINCH MOUNT PLATE FOR TRUCK	20008
	7	PREMIUM WIRELESS WINCH CONTROLLER 100-FT RANGE	20156
	8	WINCH WIRING HARNESS 2-GAUGE 24-FT	20207
	9	WINCH WIRING HARNESS 2-GAUGE 7.5-FT	20205
	10	WINCH WIRE ROPE 5/16" x 47.5-FT	20214
	10	WINCH WIRE ROPE 5/16" x 100-FT	20128
	11	WIRELESS REMOTE FOR 9850113 ATV WINCH	20099
	12	WIRELESS REMOTE FOR 9850175 & 9850172 WINCHES	20212

NOTE: Ref. No 7, Item Number 9850140 will not work with 9850175, 9850172 nor 9850113.

## OTHER BRANDED ELECTRIC WINCH REPLACEMENT PARTS

REF NO.	ITEM NO.	DESCRIPTION	ID NO.
	13	WINCH REMOTE WIRELESS FOR SUPERWINCH	06714
	14	WINCH REMOTE 30' CORD FOR SUPERWINCH	90-40308-02
	15	SOCKET ASSEMBLY FOR SUPERWINCH REMOTE	90-25048-01





IT'S NOT JUST A COUPLER

# IT'S TOTAL CONTROL

NEW  
IMPROVED  
VERSION



HEAVY DUTY // 7,000-12,500 LB.

## RIGID MOUNT COLLAR-LOK™ COUPLER

- Height adjustable
- Load leveling downward bias
- Force transfer feature to resist damage from use and abuse
- Rigid anti-rattle/jarring design
- Single-tool, easy installation



LIMITED 5 YEAR WARRANTY

[WWW.BULLDOGPRODUCTS.NET](http://WWW.BULLDOGPRODUCTS.NET)

ISO 9000 CERTIFIED  
Pat. Info.: [CEQPAT.com](http://CEQPAT.com)



**6750083**  
15K 2-5/16" Ball  
Adjustable Height  
Coupler with  
6-Hole Bracket  
and Hardware



**6750233**  
15K 2-5/16" Ball Adjustable  
Height Coupler with 4-Hole  
Bracket and Hardware

**6750247**  
10K 2" Ball Adjustable Height Coupler with  
4-Hole Bracket and Hardware



**7350934**  
Adjustable Height Tri-Ball Mount  
Black Powder Coat Finished Solid  
Shank for 2" Tubes, Welded Steel  
Chrome Hitch Balls and Individually  
Boxed.



**7350037**  
6K 8" Deep Drop Ball  
Mount for 2" Tubes  
1" Hole 10" Shank  
Powder Coated Finish



**7150085**  
2" Forged SAE King Pin with 1/4"  
Bolster Plate Thickness



**8550029**  
2-1/2" to 3" I.D. Drawbar - Pintle Combination  
Hitch Ball Interchangeable Forged Steel Hitch Ball.  
Drop Forged Alloy Steel. Black Powder Coat Finish.  
Individually Boxed. 8-Ton Capacity



**8550029**  
2" to 3" I.D. Drawbar - Pintle Hitch.  
Heavy-Duty Drop Forged Alloy Steel.  
Black Powder Coat Finish.  
Individually Boxed. 15-Ton Capacity



**8550006**  
3" I.D. Drawbar - Pintle Hook.  
Heavy Duty Forged Alloy Steel.  
Black Powder Coat Finish with Heat Treated Wear Surface and 4-Hole  
Flush Mount Base 30-Ton Capacity with 7.5-Ton Tongue Capacity  
45-Ton Capacity with Hinged Tongue Trailers with Negligible Tongue  
Load (500 lbs Max).

# COUPLER STYLES • STRAIGHT TONGUE COUPLERS =

## Coupler Styles

1. ROUND TONGUE
2. STRAIGHT CHANNEL
3. A-FRAME
4. ADJUSTABLE
5. LUNETTE RING
6. FLAT MOUNT
7. BRAKE ACTUATOR
8. GOOSENECK



## Straight Tongue Couplers

### 1-7/8" BALL COUPLER

REF NO.	ITEM NO.	CAPACITY	TONGUE SIZE	FINISH	COLLAR
1	6750521	2,000	2"	ZINC	SQUARE
-	6750522	2,000	2"	OILY	SQUARE
CT2000RK		REPAIR KIT FOR ABOVE 1-7/8" COUPLERS			
-	6750043	2,000	2.5"	OILY	SQUARE
2	6750042	2,000	3"	OILY	SQUARE

### 2" BALL COUPLER

REF NO.	ITEM NO.	CAPACITY	TONGUE SIZE	FINISH	COLLAR
3	6750523	3,500	2"	ZINC	SQUARE
-	6750524	3,500	2"	OILY	SQUARE
4	6750562	3,500	2.5"	ZINC	SQUARE
5	6750526	3,500	2.5"	OILY	SQUARE
-	6750527	3,500	3"	ZINC	SQUARE
-	6750528	3,500	3"	OILY	SQUARE
-	6750529	5,000	3"	ZINC	SQUARE
-	6750530	5,000	3"	OILY	SQUARE
6		REPAIR KIT FOR ABOVE 2" COUPLERS			
-	6750060	5,000	2"	PAINTED	SQUARE
-	6750020	3,500	3"	ZINC	SQUARE
7	6750019	3,500	3"	PAINTED	SQUARE
-	6750023	5,000	3"	PAINTED	SQUARE
8	6750022	5,000	3"	PRIMED	SQUARE
-	6750063	7,000	3"	PRIMED	SQUARE
9	6750055	5,000	2.25"	PRIMED	ROUND
-	6750059	5,000	3.5"	PRIMED	ROUND
24200	6750115	LATCH REPAIR KIT FOR ABOVE BULLDOG			
25230	6750119	REPLACEMENT RELEASE PIN FOR BULLDOG			

### 2-5/16" BALL COUPLER

REF NO.	ITEM NO.	CAPACITY	TONGUE SIZE	FINISH	COLLAR
10	6750026	8,500	3"	PAINTED	SQUARE
11	6750028	12,500	2.25"	PRIMED	ROUND
12	6750029	12,500	3"	PRIMED	SQUARE
13	6750115	24200 LATCH REPAIR KIT FOR ABOVE BULLDOG			
14	6750119	25230 REPLACEMENT RELEASE PIN FOR BULLDOG			



= COUPLER STYLES • STRAIGHT TONGUE COUPLERS



# COUPLERS • A-FRAME & ADJUSTABLE HEIGHT

## A-Frame Couplers



### 2" BALL COUPLER

REF NO.	ITEM NO.	CAPACITY	BALL SIZE	FINISH	LATCH
1	6750502-TT	5,000	2"	PAINT	TRIGGER
-	6750500-TT	5,000	2"	OILY	TRIGGER
2	6750054	5,000	2"	PAINT	YOKE
3	6750135	8,000	2"	PAINT	FLIP
4	6750512-TT	8,000	2"	PAINT	YOKE
5	6750056	5,000	2"	PAINTED	HI-PROFILE
-	6750057	5,000	2"	PAINTED	LO-PROFILE
-	6750066	7,000	2"	PAINTED	HI-PROFILE
6	6750069	7,000	2"	PAINTED	LO-PROFILE
7	6750519-TT	7,000	2"	PAINTED	LO-PROFILE

### 2-5/16" BALL COUPLER

REF NO.	ITEM NO.	CAPACITY	BALL SIZE	FINISH	LATCH
8	6750062	8,500	2-5/16"	PAINT	YOKE
9	6750505	10,000	2-5/16"	PAINT	THUMB
-	6750504	10,000	2-5/16"	OILY	THUMB
10	6750075	13,000	2-5/16"	PAINT	THUMB
11	6750507-TT	14,000	2-5/16"	PAINT	THUMB
5400O	6750506-TT	14,000	2-5/16"	OILY	THUMB
12	6750178	15,000	2-5/16"	PRIMED	TRIGGER
13	6750076	12,500	2-5/16"	PAINTED	HI-PROFILE
14	6750006-TT	12,500	2-5/16"	PAINTED	LO-PROFILE
4B8L	6750030	12,500	2-5/16"	PAINTED	LO-PROFILE
15775	6750015	REPLACEMENT LATCH FOR 6750062			
88051	6750123	REPLACEMENT KIT FOR 6750135			
5100RK	6750097	REPAIR KIT FOR 5000 SERIES A-FRAME			
24200	6750115	LATCH REPAIR KIT FOR ABOVE BULLDOG			
25230	6750119	REPLACEMENT RELEASE PIN FOR BULLDOG			
15	6750120	REPLACEMENT PIN FOR LOW PROFILE			

## Adjustable Height Couplers



### 2" BALL COUPLER

REF NO.	ITEM NO.	CAPACITY	BALL SIZE	FINISH	BRACKET
-	6750064	7,000	2"	PAINTED	CAST
16	6750200	6750064 WITH 4-HOLE 3 POSTION BRACKET			
-	6750201	6750064 WITH 6-HOLE 5 POSTION BRACKET			
19	6750120	REPLACEMENT PIN FOR LOW PROFILE			
-	6750540	7,000	2"	PAINTED	CAST
-	6750545	6750540 WITH 4-HOLE 3 POSTION BRACKET			
17	6750546	6750540 WITH 6-HOLE 5 POSTION BRACKET			
19	6750120	REPLACEMENT PIN FOR LOW PROFILE			

### 2-5/16" BALL COUPLER

REF NO.	ITEM NO.	CAPACITY	BALL SIZE	FINISH	BRACKET
-	6750563	14,000	2-5/16"	PAINTED	STAMPED
-	6750514	6750563 WITH 4-HOLE 3 POSTION BRACKET			
18	6750513	6750563 WITH 6-HOLE 5 POSTION BRACKET			

COUPLERS • A-FRAME & ADJUSTABLE HEIGHT

# COUPLERS • ADJUSTABLE HEIGHT Cont. =



## 2-5/16" BALL COUPLER

REF NO.	ITEM NO.	CAPACITY	BALL SIZE	FINISH	STYLE
-	6750027	12,500	2-5/16"	PAINTED	CAST
1	6750202	6750027 WITH 4-HOLE 3 POSITION BRACKET			
-	6750203	6750027 WITH 6-HOLE 5 POSITION BRACKET			
-	6750538	12,500	2-5/16"	PAINTED	CAST
-	6750543	6750538 WITH 4-HOLE 3 POSITION BRACKET			
2	6750544	6750538 WITH 6-HOLE 5 POSITION BRACKET			
-	6750195	14,000	2-5/16"	PAINTED	CAST
3	6750010	6750195 WITH 4-HOLE 3 POSITION BRACKET			
-	6750011	6750195 WITH 6-HOLE 5 POSITION BRACKET			
-	6750566	15,000	2-5/16"	PAINTED	CAST
4	6750568	6750566 WITH 4-HOLE 3 POSITION BRACKET			
5	6750375	21,000	2-5/16"	PAINTED	CAST
-	6750372	21,000	2-5/16"	ZINC	CAST
6	6750131	24,000	CHANNEL BRACKET 4 HOLE		
7	6750132	24,000	CHANNEL BRACKET 6 HOLE		
8	7030001	GRADE 8	5/8" x 4.5" 2 ea. BOLT & NUT		
9	6750120	REPLACEMENT PIN FOR LOW PROFILE			
-	8550027	14,000	3"	RAW	CHANNEL
10	8550036	8550027 WITH 4-HOLE 3 POSITION BRACKET			
-	8550037	8550027 WITH 6-HOLE 5 POSITION BRACKET			
11	8550051	12,000	3/4" Pin	RAW	CLEVIS
-	8550013	20,000	1" Pin	RAW	CLEVIS
-	8550052	8550051 WITH 4-HOLE 3 POSITION BRACKET			
-	8550053	8550051 WITH 6-HOLE 5 POSITION BRACKET			
-	8550050	8550013 WITH 6-HOLE 5 POSITION BRACKET			



## Gooseneck Couplers

### 2-5/16" ROUND COUPLER

REF NO.	ITEM NO.	CAPACITY	HEIGHT	DESCRIPTION
12	6750035	20,000	29.3"	3/4" PIN W/TUBE CAP
13	6750080	25,000	28.1"	CABLE RELEASE
14	6750282	25,000	27.5"	BX1 HEAD
15	6750534	25,000	29.5"	3/4" PIN 2 SET SCREWS
16	6750192	30,000	29.3"	ADJUSTABLE
-	6750002	30,000	29.5"	3/4" PIN 6750125 SET SCREWS
17	6750186	BULLDOG REPLACEMENT PIN		
18	6750304	RAM REPLACEMENT PIN		
19	6750124	COUPLER SET SCREW HEX HEAD		

= COUPLERS • ADJUSTABLE HEIGHT Cont.

# COUPLERS • GOOSENECK Cont. =



2-5/16" SQUARE COUPLER				
REF NO.	ITEM NO.	CAPACITY	HEIGHT	DESCRIPTION
1	6750305	25,000	31"	BX1 HEAD
2	6750036	25,000	32"	8" ADJUSTMENT
3	6750535	25,000	30"	8" ADJUSTMENT
4	6750048	30,000		TOP WIND
5	6750047	30,000	32"	7" ADJ - TOP WIND
6	6750536-TT	30,000	32"	7" ADJ - TOP WIND
7	6750050	30,000		10" ADJ - TOP WIND
8	6750039	24,000	32"	AUTOLOCK TOP WIND

GOOSENECK COUPLER REPLACEMENT PARTS		
REF NO.	ITEM NO.	DESCRIPTION
9	6750016	COUPLER HEAD REPAIR KIT FOR 6750035
10	6750210	COUPLER HEAD REPAIR KIT FOR 6750080
11	6750124	SET SCREW W/ JAM NUT & ADJUSTING NUT
12	6750118	K1 REPLACEMENT PIN FOR 6750048
13	6750186	BULLDOG REPLACEMENT PIN
14	6750304	RAM REPLACEMENT PIN
15	6750285	REPLACEMENT HANDLE 6750536-TT

REPLACEMENT GOOSENECK COUPLER INNER / OUTER PIPE		
REF NO.	ITEM NO.	DESCRIPTION
-	6750227	REPLACEMENT INNER PIPE FOR 6750534
16	6750234	REPLACEMENT OUTER PIPE FOR 6750534
17	6750078	REPLACEMENT INNER PIPE FOR 6750035
-	6750283	REPLACEMENT INNER PIPE FOR 6750036
18	8200407	REPLACEMENT INNER PIPE LOCKING 25K - B & W DEFENDER
19	6750206	REPLACEMENT INNER PIPE 10" OFFSET 24K

KINGPIN ADAPTERS		
REF NO.	ITEM NO.	DESCRIPTION
20	7150068	KINGPIN ADAPTER FOR 4" SQUARE COUPLERS HB
-	7150075	KINGPIN ADAPTER FOR 4" SQUARE COUPLERS PR
21	7150082	KINGPIN ADAPTER FOR 4" SQUARE ADJUSTABLE COUPLERS HB
22	7150088	KINGPIN ADAPTER FOR 4" SQUARE ADJUSTABLE COUPLERS PR
23	7150071	KINGPIN ADAPTER FOR 4.5" ROUND COUPLERS PR
20	7150070	KINGPIN ADAPTER FOR 4.5" SQUARE COUPLERS PR
23	7150057	KINGPIN ADAPTER FOR 4" ROUND COUPLERS

RV 5th WHEEL TO GOOSENECK ADAPTER		
REF NO.	ITEM NO.	DESCRIPTION
24	7350485	ADAPTER 9" OFFSET 24K
25	7350873	ADAPTER 12.5-16.5" TALL 24K
26	7351269	ADAPTER FIXED 7.5" TALL -FLATBED OLNY
27	6300297	CUSHIONED ADAPTER 12-16" TALL 20K
28	6300298	CUSHIONED ADAPTER 7.5" OFFSET 20K

2-5/16" GOOSENECK COUPLER HEADS		
REF NO.	ITEM NO.	DESCRIPTION
29	6750051	30K 1/2" LOCK PIN
30	6750037	24K CAST



= COUPLERS • GOOSENECK Cont.

# COUPLERS • DRAW BARS & PINTLE RINGS | ACCESSORIES

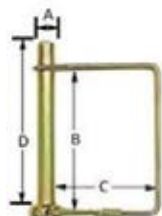
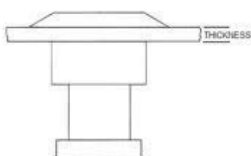

## DRAW BARS

REF NO.	ITEM NO.	CAPACITY	RING	DESCRIPTION
1	8550004	42,000	2.5"	FLANGE MOUNT
2	8550006	60,000	3"	FLANGE MOUNT
-	8550047	90,000	3"	FLANGE MOUNT
3	8550007	10,000	2.5"	FLAT MOUNT
4	8550008	15,000	2.5"	THREADED
-	8550038	44,000	3"	THREADED

REF NO.	ITEM NO.	THICKNESS	DESCRIPTION
5	8550045	3/4"	EIGHT 21/32" HOLES - 7" x 16"
-	8550046	1"	EIGHT 25/32" HOLES - 7" x 16"

REF NO.	ITEM NO.	CAPACITY	DESCRIPTION
6	8550026	60K	4ea 1/2" BOLTS, WASHERS & NUTS - GRADE 8
-	8550082	60K	4ea 3/4" BOLTS, WASHERS & NUTS - GRADE 8

## FLAT MOUNT COUPLERS

REF NO.	ITEM NO.	CAPACITY	BALL	DESCRIPTION
7	6750040	25,000	2-5/16"	ATWOOD PAINTED
8	6750009	20,000	2/5/2016	BULLDOG PAINTED

## BOLSTER PLATES

REF NO.	ITEM NO.	THICKNESS	DESCRIPTION
9	7150016	0.38"	2" FORGED SAE KING PIN
-	7150018	0.50"	2" FORGED SAE KING PIN

## Specialty Couplers Accessories

### HINGE KIT FOR FOLD-AWAY COUPLERS

REF NO.	ITEM NO.	SIZE	DESCRIPTION
10	6750229	3" X 3"	5K ZINC BOLT-ON FOLD-AWAY COUPLER HINGE
-	6750232	3" X 4"	7.5K ZINC BOLT-ON FOLD-AWAY COUPLER HINGE
11	6750216	3" X 3"	5K WELD-ON FOLD-AWAY COUPLER HINGE

### COUPLER SNAPPER PINS

ITEM NO.	DESCRIPTION	A	B	C	D
6750144	YELLOW ZINC SNAPPER PIN	3/16"	1-5/8"	1-9/16"	1-13/16"
6750141	YELLOW ZINC SNAPPER PIN	1/4"	1-13/16"	1-1/2"	2"
6750148	YELLOW ZINC SNAPPER PIN	1/4"	2-1/2"	2-1/2"	2-49/64"
6750143	YELLOW ZINC SNAPPER PIN	1/4"	3"	1-1/2"	3-1/4"
6750142	YELLOW ZINC SNAPPER PIN	1/4"	3-5/8"	1-1/2"	3-3/4"
6750140	YELLOW ZINC SNAPPER PIN	5/16"	1-5/8"	2-19/32"	2-25/32"
6750120	SNAPPER PIN WITH 6" CHAIN	5/16"	2-1/2"	1-3/4"	2-3/4"
6750145	YELLOW ZINC SNAPPER PIN	3/8"	1-17/32"	1-17/32"	1-5/8"
6750139	YELLOW ZINC SNAPPER PIN	3/8"	2-11/32"	2-11/32"	2-1/2"